

RSK[®]

I N D I A





TABLE OF CONTENTS

_____	4
_____	4
_____	
_____	
_____	5
_____	5
_____	6
_____	7

LIST OF CONTENT

- INTRODUCTION
- ABOUT US
- OUR VISION
- FACILITY
- MACHINE SETUP
- CERTIFICATES
- CLIENTS
- CONTACT DETAILS



RSK INDIA PVT LTD

"Innovation" that begins with you"

Since opening in beginning of 2017, M/s RSK India is proud to serve Indian Industrial market. RSK India committed to not only providing quality products and services, but going above and beyond to ensure our customers are completely satisfied. We welcome you to look through our site to see all we have to offer.

- **Customized SS/MS Sheet metal finish Products**
- **Telecommunication / IT & Electrical Racks**
- **Aluminum Extrusion structures**
- **ABS / SS pipe and joint structures.**
- **ESD Tables and Chairs.**
- **Heavy/Medium/Light Weight Slotted Angle racks.**
- **Wooden and metal pallets**
- **Modular wooden Furniture**
- **Industrial Furniture.**

We have developed ourselves as manufacturers and service providers of production lines & conveyors. We are specialized in designing & manufacturing of various type of working table, assembly lines & conveyor lines etc. we provide various solutions for lean production, material storage, logistics and distribution etc.

We can design & manufacture customized "Metal & Wooden" products that are in accordance to the customer's requirement.

- Customized SS/MS Sheet metal finish Products



- Telecommunication / IT & Electrical Racks

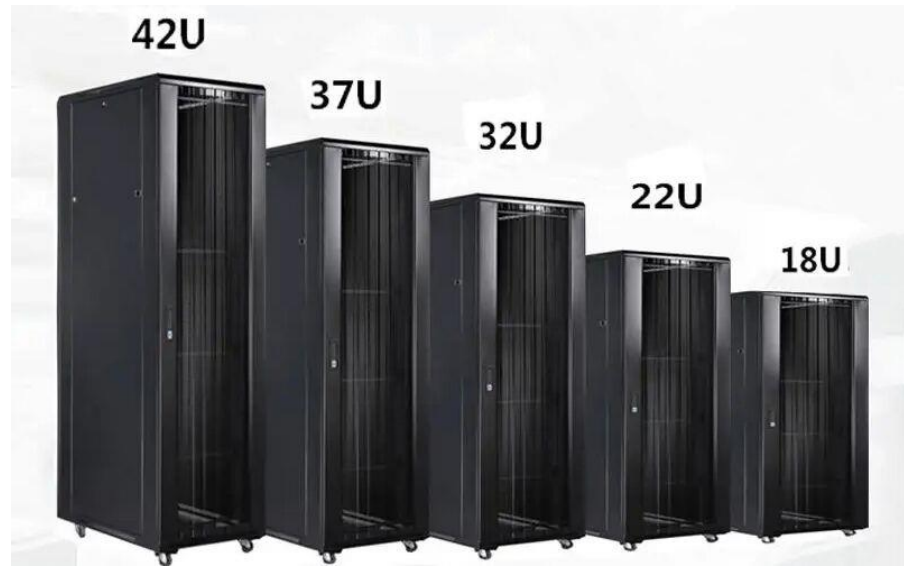

- Aluminum Extrusion structures

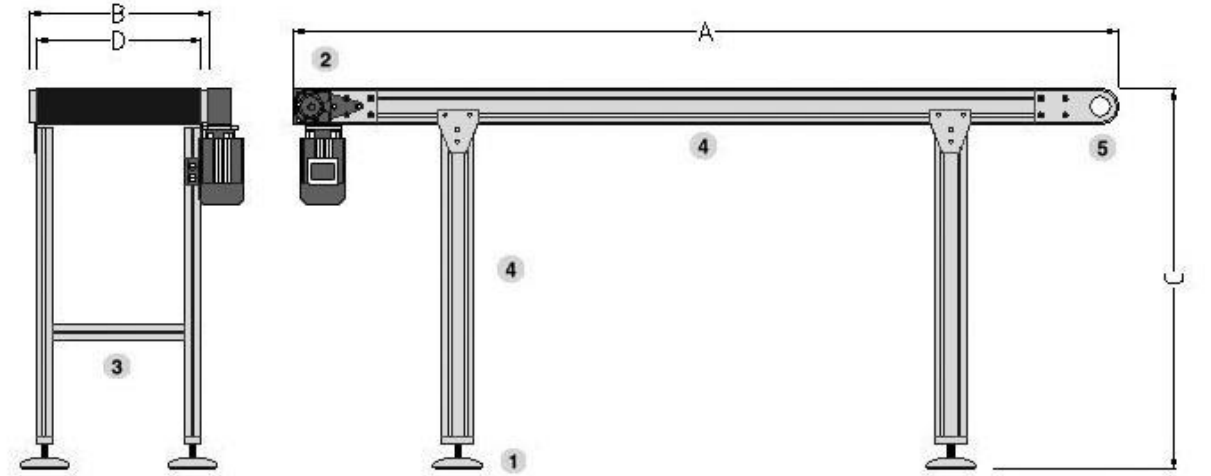

- **ABS / SS pipe and joint structures**



+



=



Lean pipe workbench



Lean pipe turnover vehicle



Lean pipe rack



Lean pipe U production line



Precise Lean tube diameter 28mm



Connector 2.3mm thick electrophosis



- ESD Tables and Chairs



Product Name	ESD Rubber Mat
Front anti-static	10e6-10e9 Ohm
Back anti-static	10e3-10e5 Ohm
Thickness optional	1.6mm /1.8mm /2mm /3mm /5mm
Width optional	within 1.2m
Length optional	within 10m
Customization	whole roll, precut, snaps



Figure 2: Typical ESD Workstation

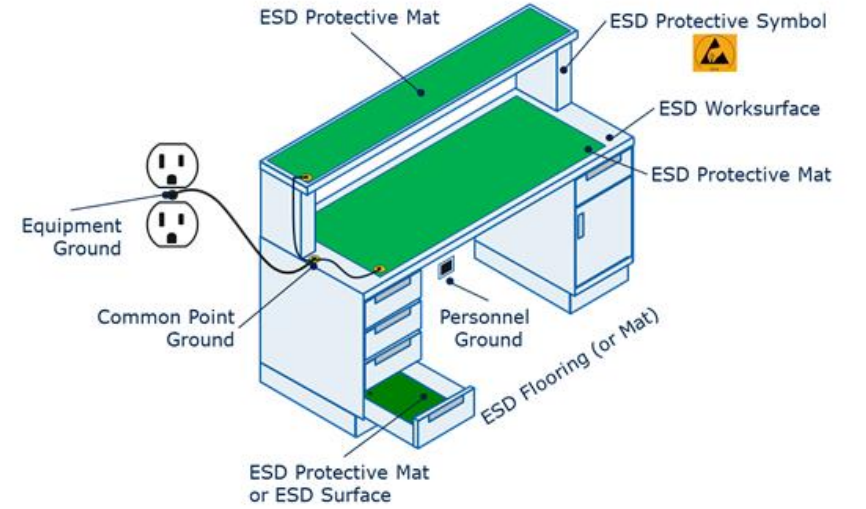

- **Heavy/Medium/Light Weight Slotted Angle racks & Pota Cabin.**



- **Wooden and metal pallets.**

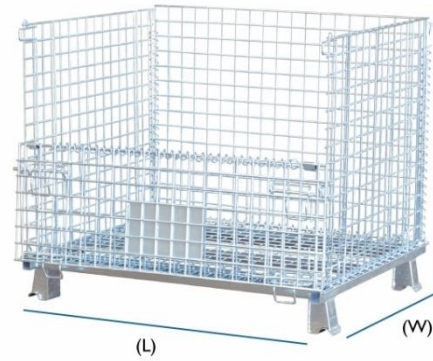

(H)

PM 3 / 5 / 7 / 9

(L)

(W)



Nestable



- **Modular wooden Furniture.**



- Industrial Solutions .

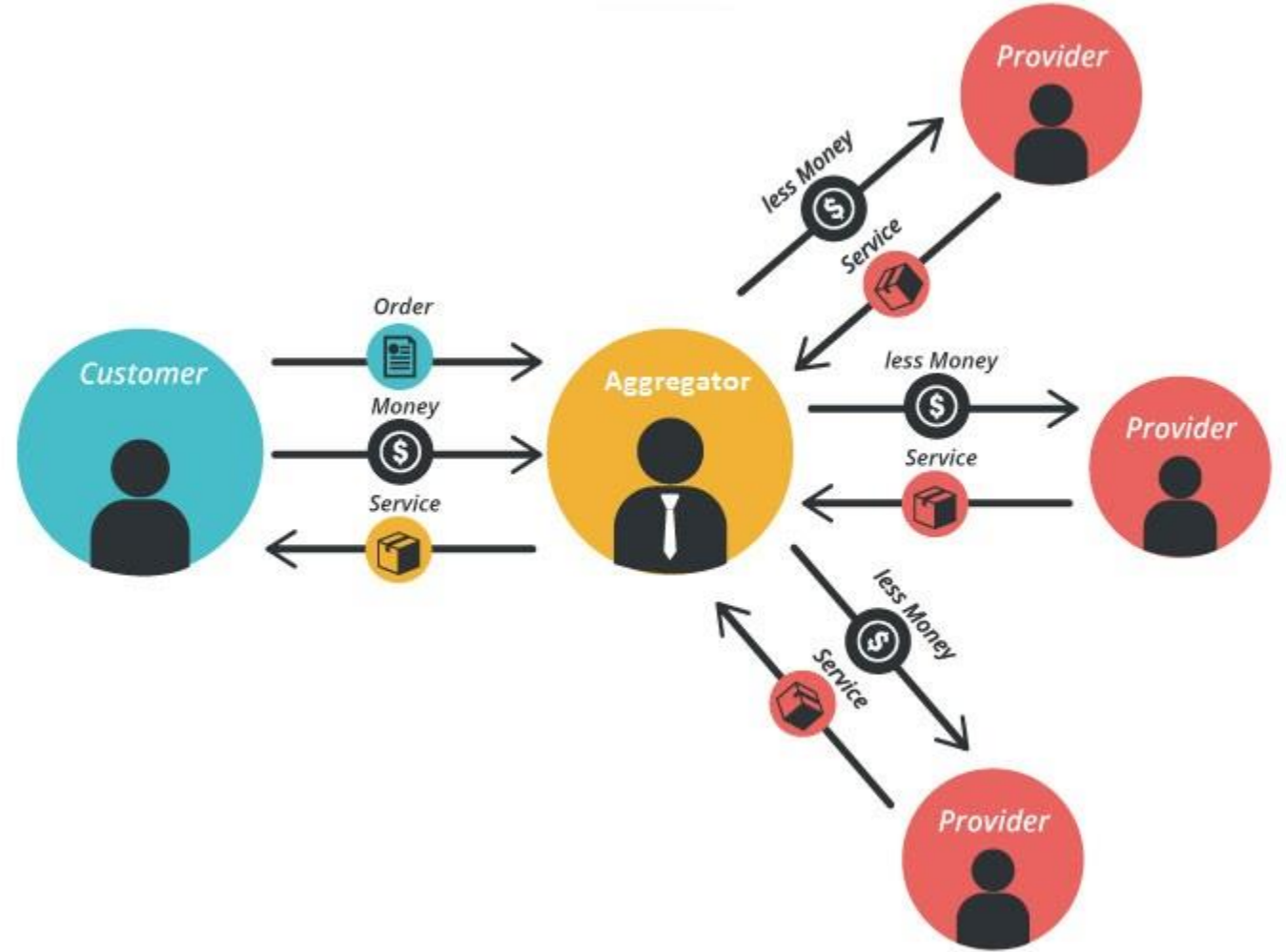



WHO WE ARE ?

A creative team of Engineers who love design & manufacturing customized systems/components that are in accordance to the customer's requirement.



HOW WE WORK ?

We collaborate closely with you to understand your goals and then apply our creative expertise, delivering bespoke solutions that exceed expectations.

WHAT WE DO ?

We transform ideas into stunning realities, crafting unique and impactful designs that resonate with your vision and your application.



We aspire to be the driving force behind manufacturing success stories.

We believe that exceptional design not only help to increase the efficiency of production and management it also attracts customers.

Our goal is to make your manufacturing facility stand out, connect with your material management need, and thrive in the competitive manufacturing landscape.

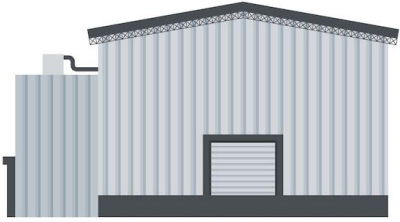

BASED IN A STATE-OF-THE-ART MANUFACTURING FACILITY, RSK INDIA PVT LTD EMPLOYS ADVANCED MACHINERY FOR IMPECCABLE PRECISION AND QUALITY IN OUR 18,000+ SQ. FT. Closed and 15000+ Sq.Ft. Open FABRICATION SETUP.



MACHINE SETUP

HSG 1.5 KW Laser unit

HSG



CONCEPT OF THE LASER CUTTING PROCESS

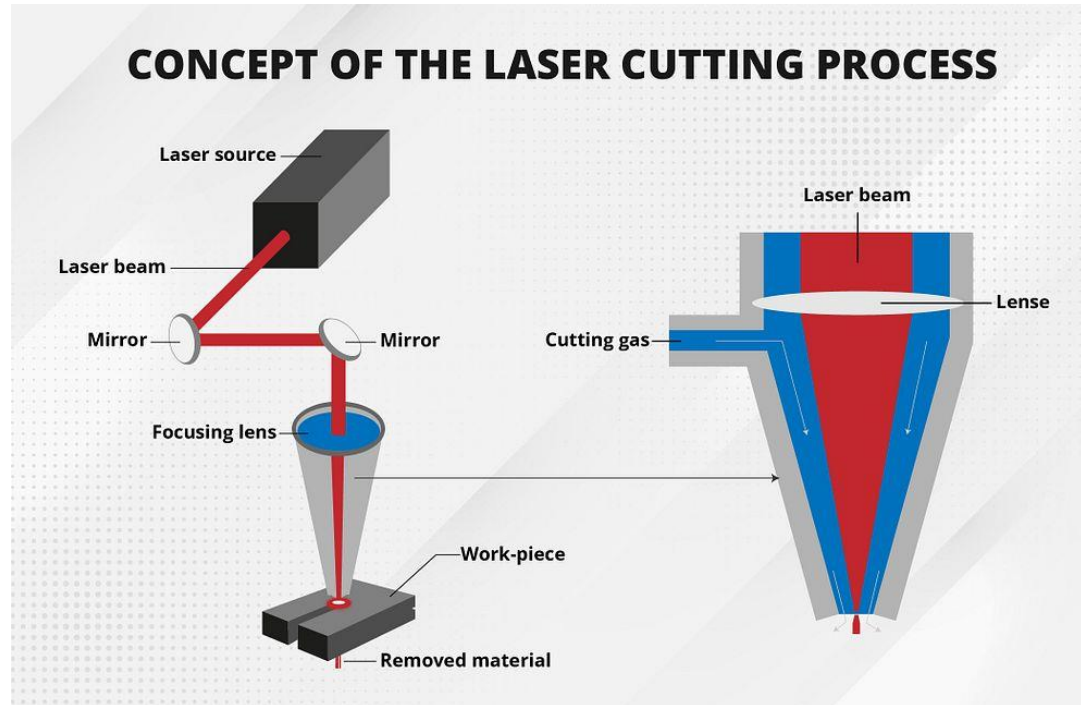

Sr. No.	Material	Cutting Thickness
1	Mild Steel	Up to 12 mm
2	Stainless steel	Up to 6 mm

MACHINE SETUP

Hindustan Hydraulics
Bending Machine 100-31

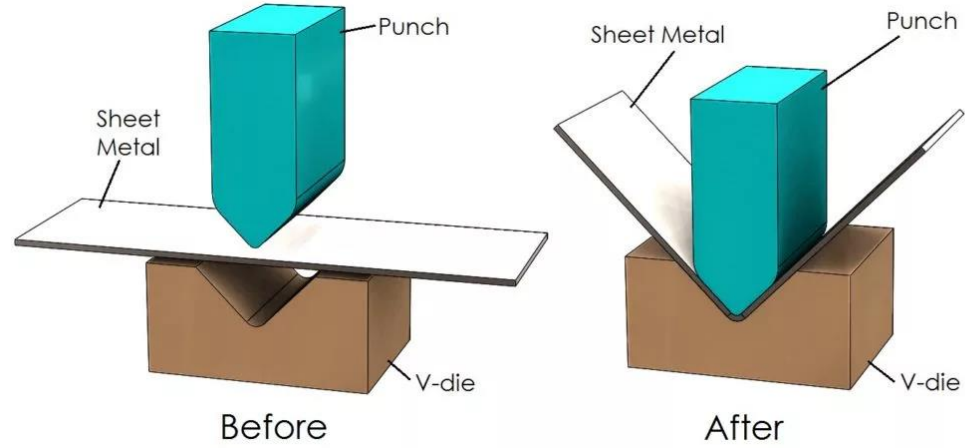

Sr. No.		
1	Tone	100 tone
2	Length	3100 mm

MACHINE SETUP

Welding Machine

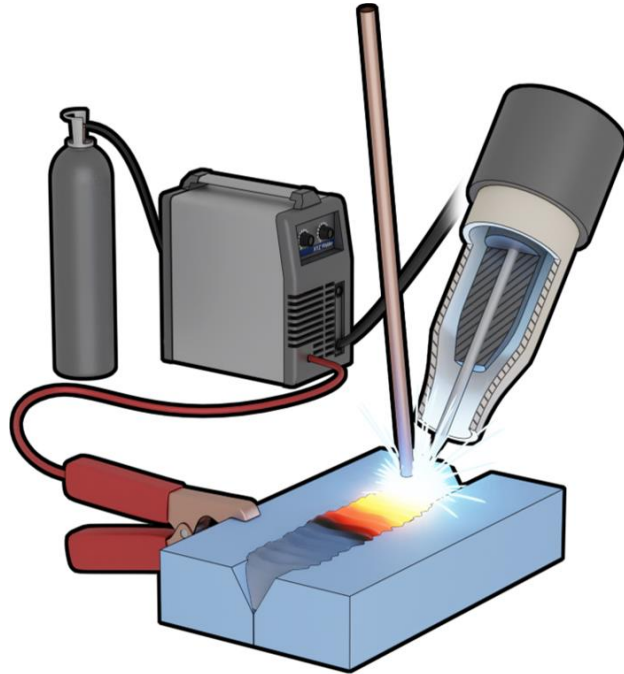

Sr. No.	Item	Qty
1	MIG Welding	10
2	Argon Welding	2
3	Arc Welding	5

MACHINE SETUP

75 KVA Spot Welding Machine with copper bed

75KVA SPOT WELDING MACHINE

SPECIFICATIONS:

- Input Voltage: 415 V (Two Phase)
- Cooling Electrode: Water
- Cooling Transformer: Air Cooled
- User Friendly
- Digital Control Panel with input
- Voltage indication meter
- Squeeze - Weld - Hold System

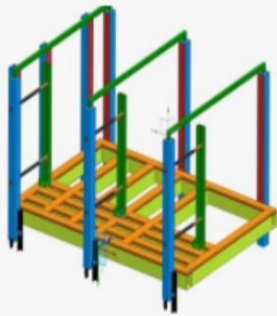

75 KVA

MACHINE SETUP

Spot Welding Machine



Spot Welding Principle

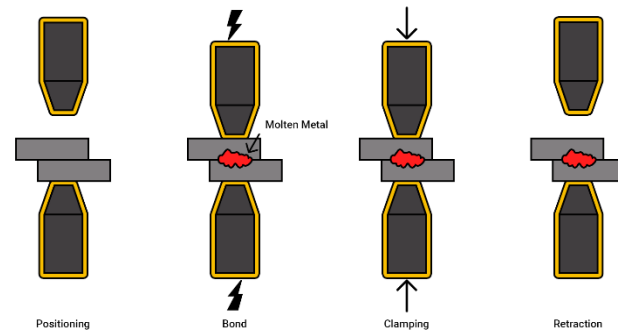
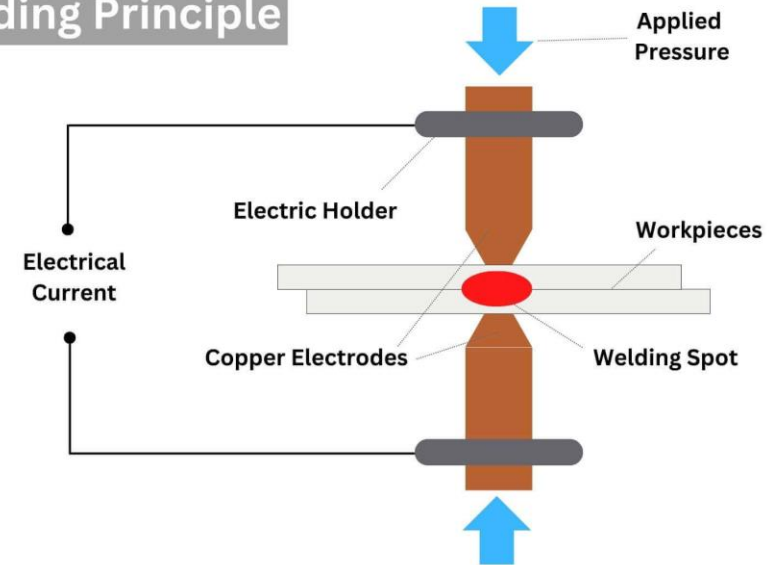

MACHINE SETUP

Clinching Machine



LOCATED

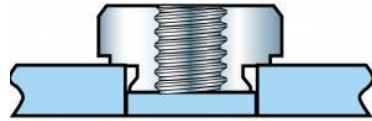

Fastener is Placed into Hole in Sheet.

FORCE

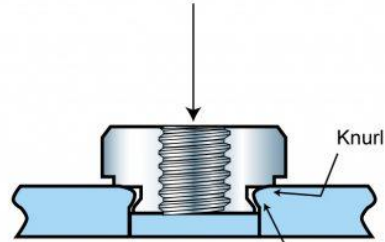

As Force is applied to Fastener, the knurl will displace material and it will begin to "Flow" into the undercut area.

INSTALLED

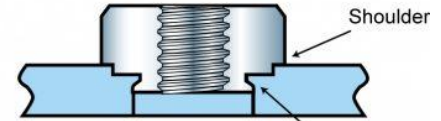

Force is applied until the shoulder of the fastener is seated flush with the Sheet. At this point, the displaced metal has filled the undercut and the fastener is locked in place.



MACHINE SETUP

Drilling Machine

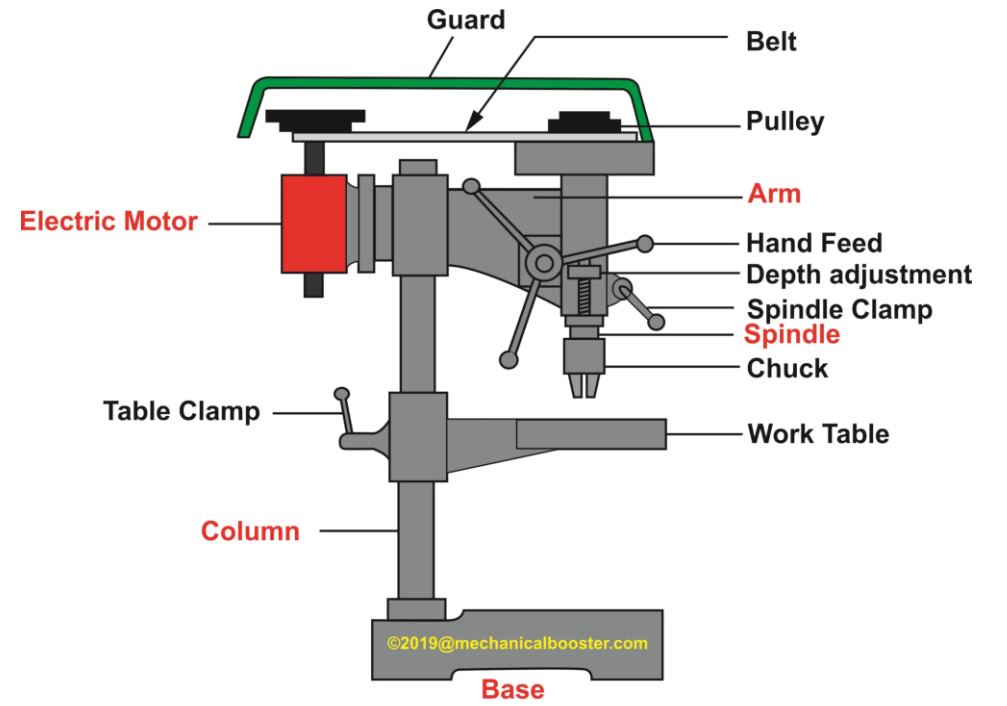
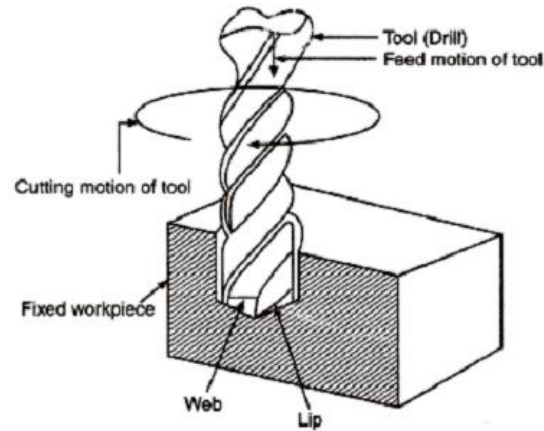

Main Parts of Drilling Machine

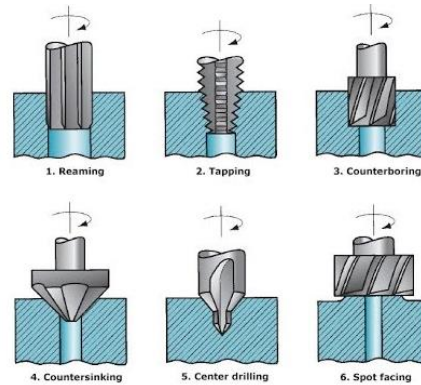

Press Working Operations

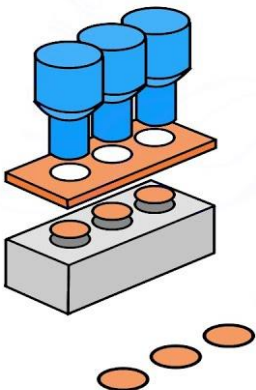
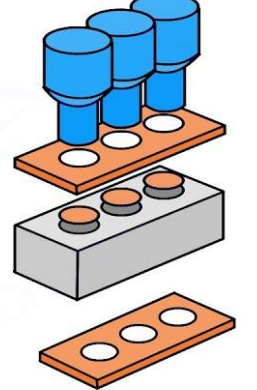
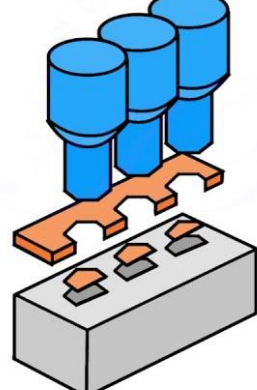
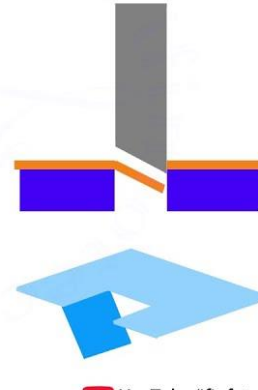
Punching Piercing	Blanking	Notching	Lancing
 A diagram showing three blue cylindrical punches on an orange die. Below, a grey workpiece has three circular holes, and three orange circular chips are shown falling away.	 A diagram showing three blue cylindrical punches on an orange die. Below, a grey workpiece has three circular holes, and a rectangular orange blank with three holes is shown.	 A diagram showing three blue cylindrical punches on an orange die. Below, a grey workpiece has three notches, and three orange notched pieces are shown.	 A diagram showing a grey die with a rectangular hole. A yellow strip of material is being processed. Below, a blue L-shaped piece and a grey rectangular piece are shown. A small red YouTube logo and the text 'YouTube/lfinfotech' are at the bottom right.

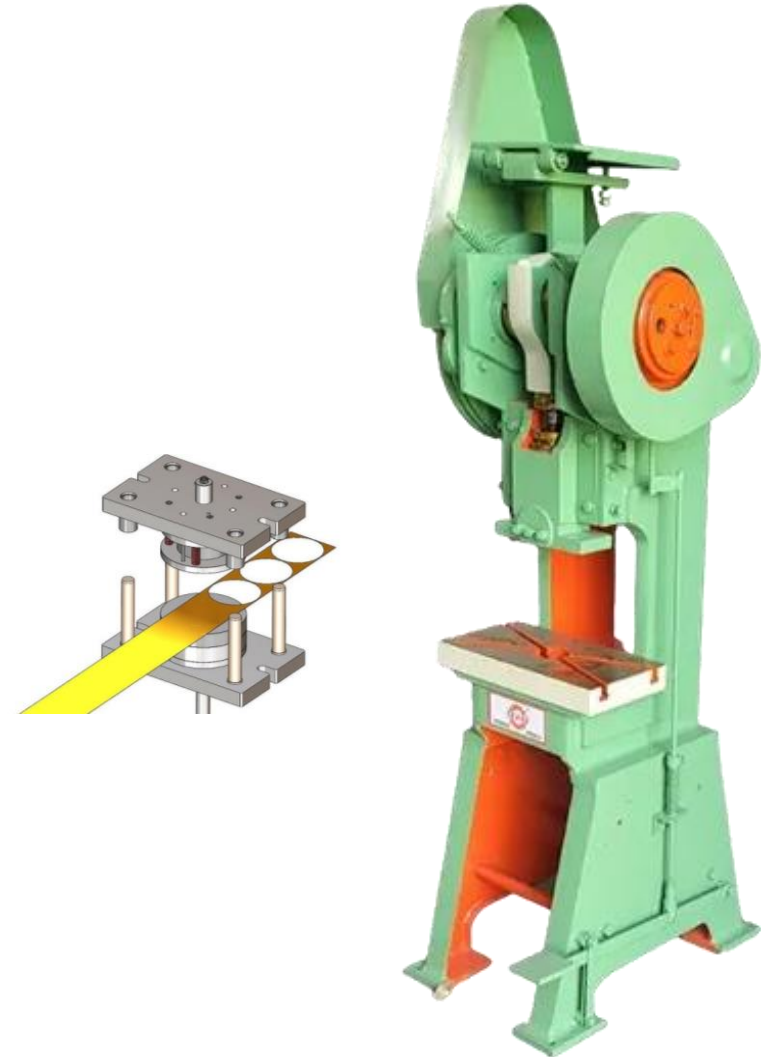

MACHINE SETUP

Wood Panel Saw

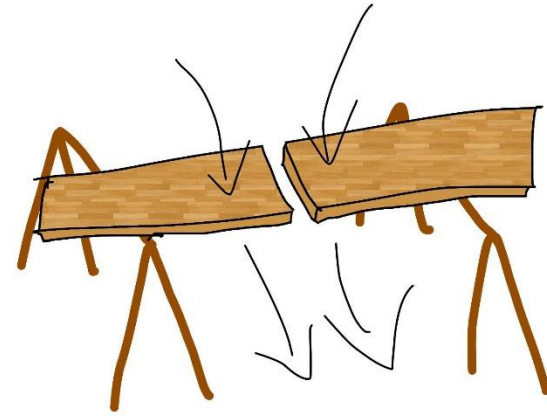

MACHINE SETUP

Wooden Hydraulic Cold Press

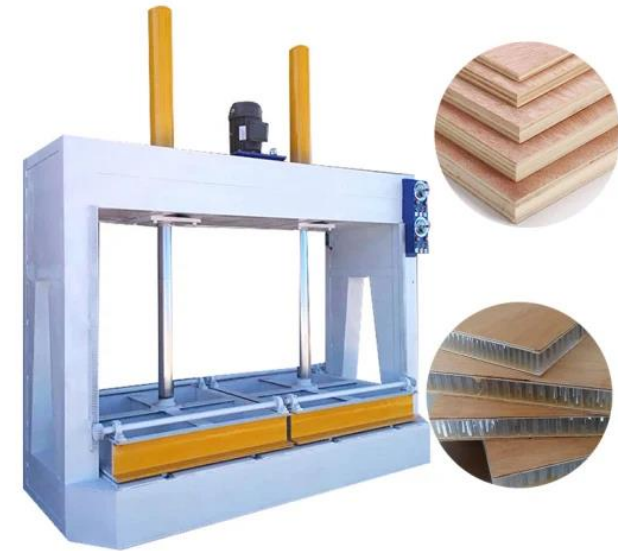
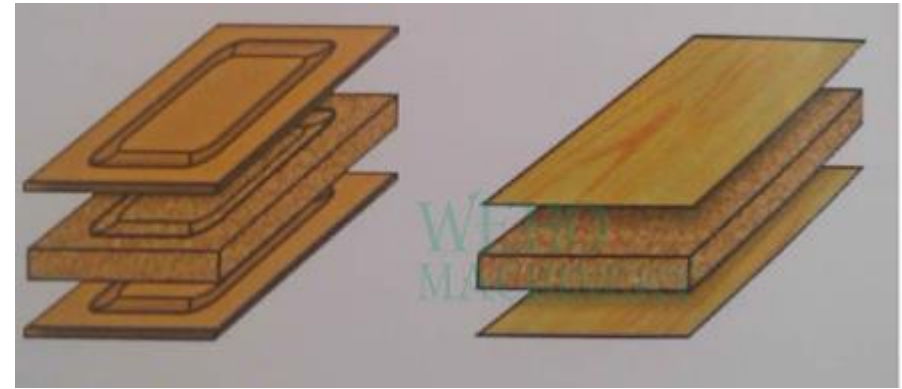

MACHINE SETUP

Automatic Edge Bending

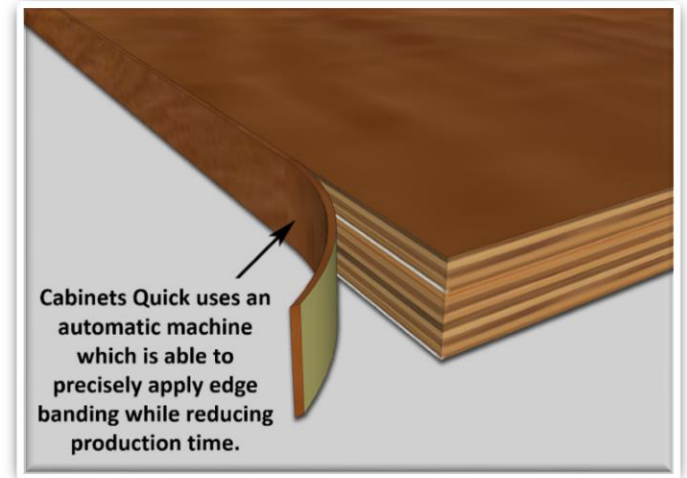
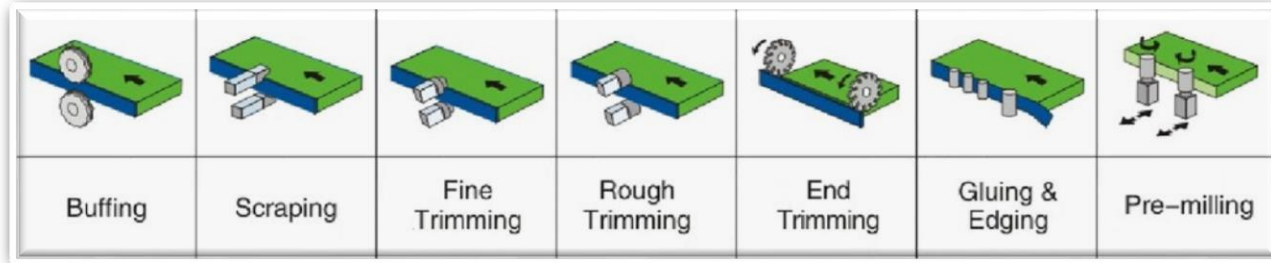

MACHINE SETUP

CNC ROUTER

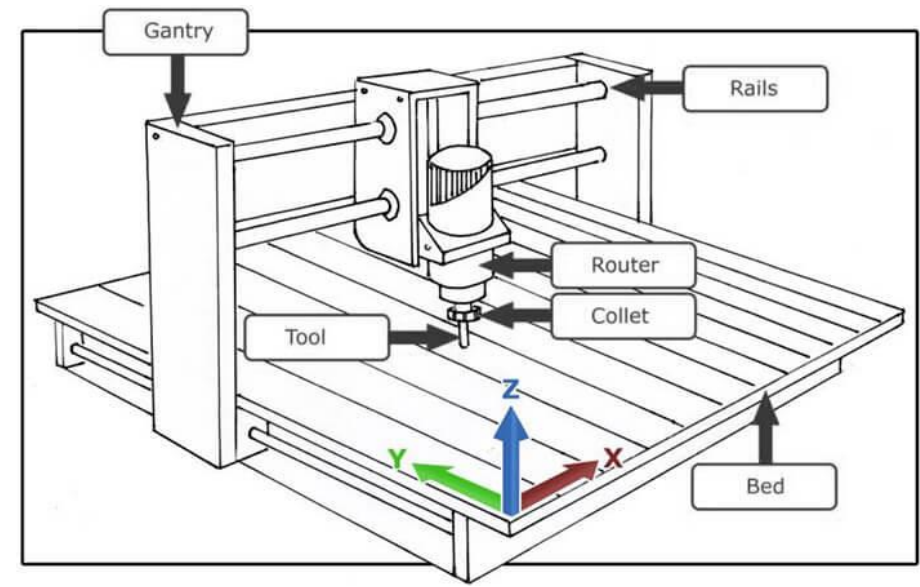
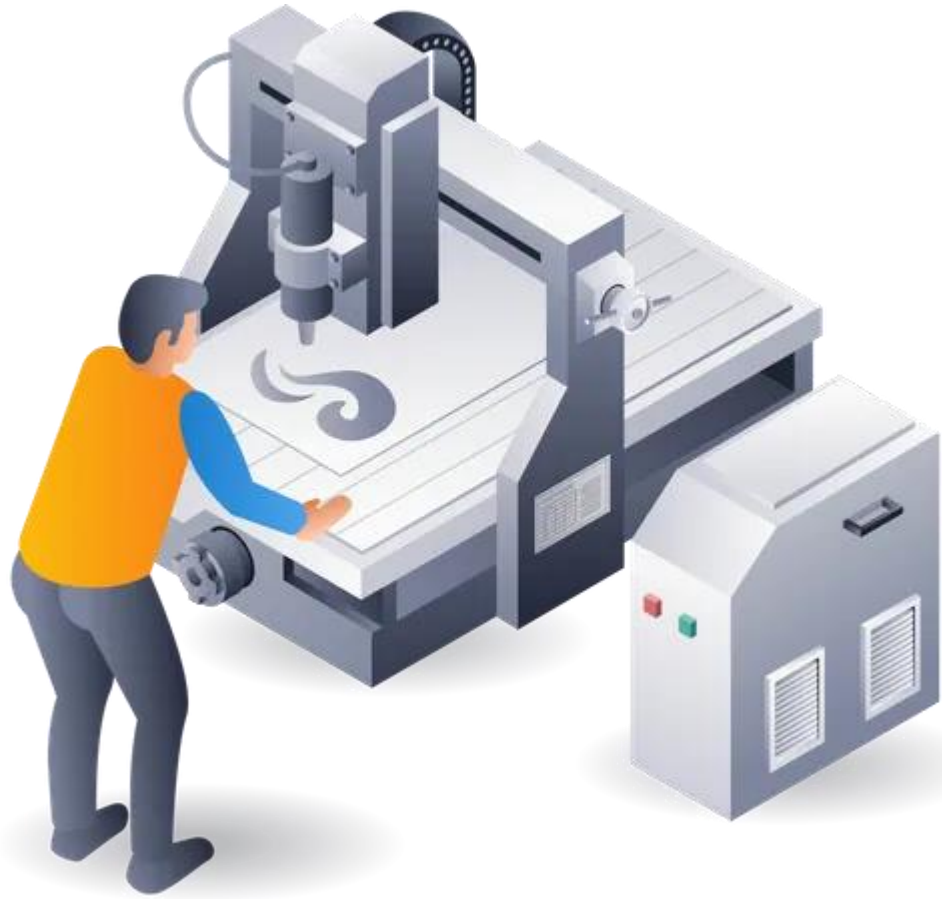

MACHINE SETUP

Manual Edge
Bending

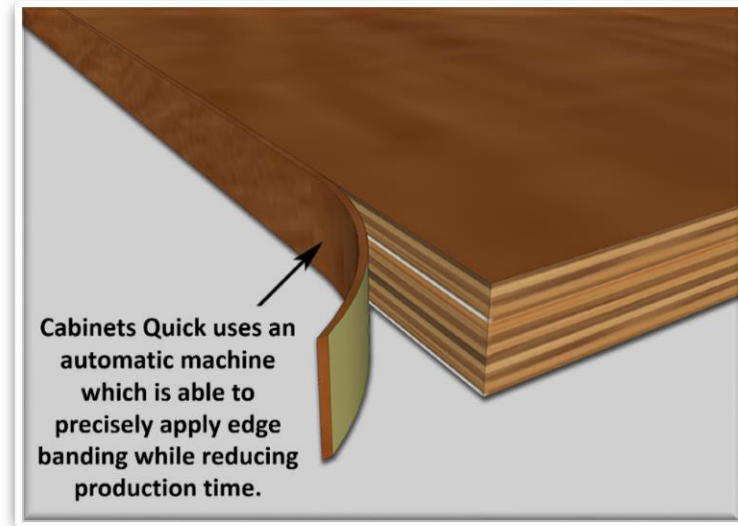
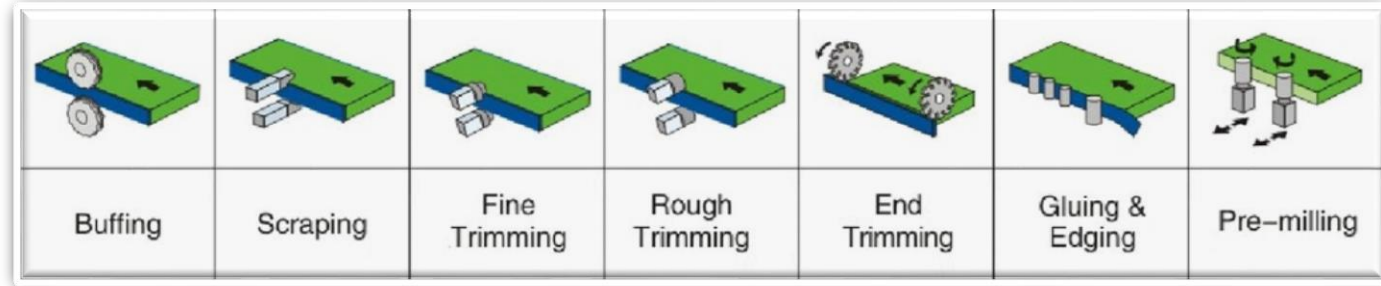

MACHINE SETUP

Power Back-up by Mahindra DG SET Three Phase with Manual Start Panel, Water cooled , CPCBIV+ Engine Model-V4355G2



CERTIFICATION



Certificate of Registration

Fostering Aspirations for Enhanced Glory

This is to certify that

RSK INDIA PRIVATE LIMITED
Khasra No. - 934/911/249, Main Basai Garhi Road Basai, Tehsil - Kadipur,
Gurugram - 122101 Haryana (India)

has been assessed by RICL and found to comply with the requirements of

ISO 9001 : 2015

Quality Management System

For the following activities:

Customized Manufacturing & Trading of Aluminum Extrusion Structure, ABS / SS Pipe and Joint Structure, Customised SS / MS Sheet Metal Structure, Heavy / Medium / Light Weight Slotted Angle Racks , Rubber and Plastic Products, ESD Products, Modular Furniture , Industrial Furniture.

This Certificate is Valid from 22/03/2023 Until 21/03/2024

Date of Initial Certification: 22/03/2023
1st Surveillance on or before: 21/02/2024
2nd Surveillance on or before: 21/02/2025
Certification Valid Until: 21/03/2026



Certificate No:
23RN03CL



Truth is in
Director
Royal Impact Certification Ltd.
623, Tower-B, (Thum), Plot No. A-46, Sector-62, Noida, 201301, India.
www.riclindia.org, info@riclindia.org
Phone: +91 120 4113863

This certificate can be verified at www.riclindia.org or at www.iafcertification.org

IAF is member of International Accreditation Forum (IAF), the membership status can be verified at www.iaf.org. This Certificate remains the property of Royal Impact Certification Limited. Must be returned on request or if certificate is withdrawn. Validity of this certificate is subject to successful surveillance audits as per defined rules above.



Certificate of Registration

Fostering Aspirations for Enhanced Glory

This is to certify that

RSK INDIA PRIVATE LIMITED
Khasra No. - 934/911/249, Main Basai Garhi Road Basai, Tehsil - Kadipur,
Gurugram - 122101 Haryana (India)

has been assessed by RICL and found to comply with the requirements of

ISO 14001 : 2015

Environmental Management System

For the following activities:

Customized Manufacturing & Trading of Aluminum Extrusion Structure, ABS / SS Pipe and Joint Structure, Customised SS / MS Sheet Metal Structure, Heavy / Medium / Light Weight Slotted Angle Racks , Rubber and Plastic Products, ESD Products, Modular Furniture , Industrial Furniture.

This Certificate is Valid from 22/03/2023 Until 21/03/2024

Date of Initial Certification: 22/03/2023
1st Surveillance on or before: 21/02/2024
2nd Surveillance on or before: 21/02/2025
Certification Valid Until: 21/03/2026



Certificate No:
23RN03CM



Truth is in
Director
Royal Impact Certification Ltd.
623, Tower-B, (Thum), Plot No. A-46, Sector-62, Noida, 201301, India.
www.riclindia.org, info@riclindia.org
Phone: +91 120 4113863

This certificate can be verified at www.riclindia.org or at www.iafcertification.org

IAF is member of International Accreditation Forum (IAF), the membership status can be verified at www.iaf.org. This Certificate remains the property of Royal Impact Certification Limited. Must be returned on request or if certificate is withdrawn. Validity of this certificate is subject to successful surveillance audits as per defined rules above.



Certificate of Registration

Fostering Aspirations for Enhanced Glory

This is to certify that

RSK INDIA PRIVATE LIMITED
Khasra No. - 934/911/249, Main Basai Garhi Road Basai, Tehsil - Kadipur,
Gurugram - 122101 Haryana (India)

has been assessed by RICL and found to comply with the requirements of

ISO 45001 : 2018

Occupational Health & Safety Management System

For the following activities:

Customized Manufacturing & Trading of Aluminum Extrusion Structure, ABS / SS Pipe and Joint Structure, Customised SS / MS Sheet Metal Structure, Heavy / Medium / Light Weight Slotted Angle Racks , Rubber and Plastic Products, ESD Products, Modular Furniture , Industrial Furniture.

This Certificate is Valid from 22/03/2023 Until 21/03/2024

Date of Initial Certification: 22/03/2023
1st Surveillance on or before: 21/02/2024
2nd Surveillance on or before: 21/02/2025
Certification Valid Until: 21/03/2026



Certificate No:
23RN03CN



Truth is in
Director
Royal Impact Certification Ltd.
623, Tower-B, (Thum), Plot No. A-46, Sector-62, Noida, 201301, India.
www.riclindia.org, info@riclindia.org
Phone: +91 120 4113863

This certificate can be verified at www.riclindia.org or at www.iafcertification.org

IAF is member of International Accreditation Forum (IAF), the membership status can be verified at www.iaf.org. This Certificate remains the property of Royal Impact Certification Limited. Must be returned on request or if certificate is withdrawn. Validity of this certificate is subject to successful surveillance audits as per defined rules above.

CERTIFICATION

CERTIFICATE



CERTIFICATE

This is to Certify that

RSK INDIA PRIVATE LIMITED

KHASRA NO. 934/911/249, MAIN BASAI GARHI ROAD BASAI, TEHSIL
KADIPUR, GURUGRAM, HARYANA - 122101, INDIA

has been independently assessed and is compliant with the requirements of:

ISO 50001:2018

(Energy Management System)

This certificate is applicable to the following product or service ranges:

CUSTOMIZED MANUFACTURING & TRADING OF ALUMINUM
EXTRUSION STRUCTURE, ABS/SS PIPE AND JOINT STRUCTURE,
CUSTOMIZED SS / MS SHEET METAL STRUCTURE,
HEAVY / MEDIUM / LIGHT WEIGHT SLOTTED ANGLE RACKS,
RUBBER AND PLASTIC PRODUCTS, ESD PRODUCTS, MODULAR
FURNITURE, INDUSTRIAL FURNITURE

Certificate No.: SPC24E9170 Date of Initial Registration: 02-05-2024
1st Surveillance audit on or before: 01-05-2025
2nd Surveillance audit on or before: 01-05-2026
Date of Recertification: 02-05-2027

Jickel
Authorised Signatory
SP Certification Limited
130, Old Street, London,
EC1V9BD, U.K.
Email: info@spcertification.co.uk
www.spcertification.co.uk
Company No. 11668116





Accredited by Accreditation Forum of International Standards (AFIST) (UK) LTD.
8, Park View Road, Leeds, LS4 2LG, United Kingdom (UK), Email: info@afist.org, Website: www.afist.org
The approval is subject to the company maintaining its system to the required standards, which will be monitored by SPC.
The Certificate remains the property of SPC and must be returned on request.
To check validity of this certificate please visit www.spcertification.co.uk and www.afist.org

Verify Certificates

CERTIFICATE



CERTIFICATE

*Of Compliance
This is to Certify that*

RSK INDIA PRIVATE LIMITED

KHASRA NO. 934/911/249, MAIN BASAI GARHI ROAD BASAI, TEHSIL
KADIPUR, GURUGRAM, HARYANA - 122101, INDIA

has been independently assessed and is compliant with the requirements of:

AIOTA

This certificate is applicable to the following product or service ranges:

CUSTOMIZED MANUFACTURING & TRADING OF ALUMINUM
EXTRUSION STRUCTURE, ABS/SS PIPE AND JOINT STRUCTURE,
CUSTOMIZED SS / MS SHEET METAL STRUCTURE,
HEAVY / MEDIUM / LIGHT WEIGHT SLOTTED ANGLE RACKS,
RUBBER AND PLASTIC PRODUCTS, ESD PRODUCTS, MODULAR
FURNITURE, INDUSTRIAL FURNITURE

This certificate refers to the information examined and read with manufacturer's declaration of conformity.
Further, the product liability rests with the manufacturer or his representative in accordance with AIOTA.
SP Certification Ltd. is not affiliated with the AIOTA.

Certificate No.: SPC24A9161 Date of Initial Registration: 01-05-2024
1st Surveillance audit on or before: 30-04-2025
2nd Surveillance audit on or before: 30-04-2026
Date of Recertification: 01-05-2027

Jickel
Authorised Signatory
SP Certification Limited
130, Old Street, London,
EC1V9BD, U.K.
Email: info@spcertification.co.uk
www.spcertification.co.uk
Company No. 11668116





Accredited by Accreditation Forum of International Standards (AFIST) (UK) LTD.
8, Park View Road, Leeds, LS4 2LG, United Kingdom (UK), Email: info@afist.org, Website: www.afist.org
The approval is subject to the company maintaining its system to the required standards, which will be monitored by SPC.
The Certificate remains the property of SPC and must be returned on request.
To check validity of this certificate please visit www.spcertification.co.uk and www.afist.org

Verify Certificates

CERTIFICATE



CERTIFICATE

*Of Compliance
This is to Certify that the*

RSK INDIA PRIVATE LIMITED

KHASRA NO. 934/911/249, MAIN BASAI GARHI ROAD BASAI, TEHSIL
KADIPUR, GURUGRAM, HARYANA - 122101, INDIA

has been independently assessed and is compliant with the requirements of:

BIFMA LEVEL – 3 Certified

ANSI/BIFMA e3-2019 Furniture Sustainability Standard

This certificate is applicable to the following product or service ranges:

CUSTOMIZED MANUFACTURING & TRADING OF ALUMINUM
EXTRUSION STRUCTURE, ABS/SS PIPE AND JOINT STRUCTURE,
CUSTOMIZED SS / MS SHEET METAL STRUCTURE,
HEAVY / MEDIUM / LIGHT WEIGHT SLOTTED ANGLE RACKS,
RUBBER AND PLASTIC PRODUCTS, ESD PRODUCTS, MODULAR
FURNITURE, INDUSTRIAL FURNITURE

(We hereby confirm that the technical file for the above mentioned furniture as produced to us comply with the essential requirements of ANSI/BIFMA e3-2019 by verification, in case of alteration of the product, not agreed up on by us, this declaration will lose its validity. The statement is based on single evaluation of one sample of above mentioned products. It does not imply an assessment of the whole production. The compliance certificate issued as per given documents & information by the organization.)

Certificate No.: SPC24B9162 Date of Initial Registration: 01-05-2024
1st Surveillance audit on or before: 30-04-2025
2nd Surveillance audit on or before: 30-04-2026
Date of Recertification: 01-05-2027

Jickel
Authorised Signatory
SP Certification Limited
130, Old Street, London,
EC1V9BD, U.K.
Email: info@spcertification.co.uk
www.spcertification.co.uk
Company No. 11668116





Accredited by Accreditation Forum of International Standards (AFIST) (UK) LTD.
8, Park View Road, Leeds, LS4 2LG, United Kingdom (UK), Email: info@afist.org, Website: www.afist.org
The approval is subject to the company maintaining its system to the required standards, which will be monitored by SPC.
The Certificate remains the property of SPC and must be returned on request.
To check validity of this certificate please visit www.spcertification.co.uk and www.afist.org

Verify Certificates

CERTIFICATION

CERTIFICATE



CERTIFICATE

Of Compliance

This is to certify that the technical documentation has been independently assessed and compliant with the requirements of General Product Safety Directive 2001/95/EC.

Manufacturer

Name : RSK INDIA PRIVATE LIMITED

Address : KHASRA NO. 934/911/249, MAIN BASAI GARHI ROAD BASAI, TEHSIL KADIPUR, GURUGRAM, HARYANA - 122101, INDIA

Product Details : ALUMINUM EXTRUSION STRUCTURE, ABS/SS PIPE AND JOINT STRUCTURE, CUSTOMIZED SS / MS SHEET METAL STRUCTURE, HEAVY/MEDIUM/LIGHT WEIGHT SLOTTED ANGLE RACKS, RUBBER AND PLASTIC PRODUCTS, MODULAR FURNITURE, INDUSTRIAL FURNITURE

Applicable Standard : Directive 2001/95/EC

This certificate refers to the information examined and read with manufacturer's declaration of conformity. Further, the product liability rests with the manufacturer or his representative in accordance with the council directive 2001/95/EC. The CE Mark as shown below can be used, under the responsibility of manufacturer, after completion of a CE Declaration of conformity and compliance with the relevant CE Directives.

Certificate No.: SPC24C9163	Date of Initial Registration: 01-05-2024
	1st Surveillance audit on or before: 30-04-2025
	2nd Surveillance audit on or before: 30-04-2026
	Date of Recertification: 01-05-2027

Judeh
Authorised Signatory

SP Certification Limited
130, Old Street, London,
EC1V9SD, U.K.
Email: info@spcertification.co.uk
www.spcertification.co.uk
Company No. 11668116





Accredited by Accreditation Forum of International Standards (AFIST (UK) LTD.)
9, Park View Road, Leeds, LS4 2LG, United Kingdom (UK), Email: info@afist.org, Website: www.afist.org
The approval is subject to the company maintaining its system to the required standards, which will be monitored by SPC.
The Certificate remains the property of SPC and must be returned on request.
To check validity of this certificate please visit www.spcertification.co.uk and www.afist.org



Verify Certificates

CERTIFICATE



CERTIFICATE

Of Compliance
This is to Certify that the

RSK INDIA PRIVATE LIMITED

KHASRA NO. 934/911/249, MAIN BASAI GARHI ROAD BASAI, TEHSIL KADIPUR, GURUGRAM, HARYANA - 122101, INDIA

has been independently assessed and is compliant with the requirements



GREENGUARD COMPLIANCE

For low emitting products and materials under the standards of the institute
This certificate is applicable to the following product or service ranges:

CUSTOMIZED MANUFACTURING & TRADING OF ALUMINUM EXTRUSION STRUCTURE, ABS/SS PIPE AND JOINT STRUCTURE, CUSTOMIZED SS / MS SHEET METAL STRUCTURE, HEAVY / MEDIUM / LIGHT WEIGHT SLOTTED ANGLE RACKS, RUBBER AND PLASTIC PRODUCTS, ESD PRODUCTS, MODULAR FURNITURE, INDUSTRIAL FURNITURE

This certificate refers to the information examined and read with manufacturer's declaration of conformity. Further, the product liability rests with the manufacturer or his representative in accordance with the standard.

Certificate No.: SPC24G9164	Date of Initial Registration: 01-05-2024
	1st Surveillance audit on or before: 30-04-2025
	2nd Surveillance audit on or before: 30-04-2026
	Date of Recertification: 01-05-2027

Judeh
Authorised Signatory

SP Certification Limited
130, Old Street, London,
EC1V9SD, U.K.
Email: info@spcertification.co.uk
www.spcertification.co.uk
Company No. 11668116





Accredited by Accreditation Forum of International Standards (AFIST (UK) LTD.)
9, Park View Road, Leeds, LS4 2LG, United Kingdom (UK), Email: info@afist.org, Website: www.afist.org
The approval is subject to the company maintaining its system to the required standards, which will be monitored by SPC.
The Certificate remains the property of SPC and must be returned on request.
To check validity of this certificate please visit www.spcertification.co.uk and www.afist.org



Verify Certificates

CERTIFICATE



CERTIFICATE

Of Compliance
This is to Certify that the

RSK INDIA PRIVATE LIMITED

KHASRA NO. 934/911/249, MAIN BASAI GARHI ROAD BASAI, TEHSIL KADIPUR, GURUGRAM, HARYANA - 122101, INDIA

has been independently assessed and is compliant with the requirements



GREENPRO COMPLIANCE

This certificate is applicable to the following product or service ranges:

CUSTOMIZED MANUFACTURING & TRADING OF ALUMINUM EXTRUSION STRUCTURE, ABS/SS PIPE AND JOINT STRUCTURE, CUSTOMIZED SS / MS SHEET METAL STRUCTURE, HEAVY / MEDIUM / LIGHT WEIGHT SLOTTED ANGLE RACKS, RUBBER AND PLASTIC PRODUCTS, ESD PRODUCTS, MODULAR FURNITURE, INDUSTRIAL FURNITURE

This certificate refers to the information examined and read with organization's declaration of conformity. Further, the product/service liability rests with the organization or his representative in accordance with the standard.

Certificate No.: SPC24G9165	Date of Initial Registration: 01-05-2024
	1st Surveillance audit on or before: 30-04-2025
	2nd Surveillance audit on or before: 30-04-2026
	Date of Recertification: 01-05-2027

Judeh
Authorised Signatory

SP Certification Limited
130, Old Street, London,
EC1V9SD, U.K.
Email: info@spcertification.co.uk
www.spcertification.co.uk
Company No. 11668116





Accredited by Accreditation Forum of International Standards (AFIST (UK) LTD.)
9, Park View Road, Leeds, LS4 2LG, United Kingdom (UK), Email: info@afist.org, Website: www.afist.org
The approval is subject to the company maintaining its system to the required standards, which will be monitored by SPC.
The Certificate remains the property of SPC and must be returned on request.
To check validity of this certificate please visit www.spcertification.co.uk and www.afist.org



Verify Certificates



Our Client





Our Client



Livguard

TDK

OKAYA

MAHLE

LECTRIX
Born Electric

NAVITASYS

MAUTO ELECTRIC
AUTO

FCT
ENERGY

spiro

Battery Smart

GREENFUEL

NAPINO

SFC
ENERGY

CMNO
Nagata Group (India Operations)

Metso:Outotec

ANEVOLVE

MOVING

EURONICS

KAYNES
TECHNOLOGY



**Our
Client**





Contact Us

THANK YOU



Address:

RSK INDIA PVT LTD,
Sector 37C, Gurugram, Haryana
122101



Contact Number:

Mobile No : +91-8561941125
Mobile No : +91-7300158600



Email id:

info@rskindia.co.in
shakti@rskindia.co.in